

ORBIT Valves

Unique tilt-and-turn design for fast, low-torque operation and long-term, reliable performance in applications when zero leakage and frequent operation are demanded.

TECHNOLOGY



Table of Contents

ORBIT VALVES

Standard Features	2
Quality Assurance	3
Operating Principle	4
Market Operations.....	5
Product Range and Options	6
How to Order	7
One-piece Stem, Enclosed Bonnet Valves Details and Materials	8
Two-piece Stem, Enclosed Bonnet Valves Details and Materials.....	10
One-piece Stem, OS&Y Bonnet Valves Details and Materials.....	12
Two-piece Stem, OS&Y Bonnet Valves Details and Materials.....	14
End Flange Bolting Dimensions	16
Seat and Stem Packing Selection.....	18
Markings	19
Actuator Figure Numbers	20
CAMSERV Services for Valves and Actuation	23
Trademark Information	24

ORBIT Valves

STANDARD FEATURES

Cameron's ORBIT® valves are ideal for applications when zero leakage and frequent operation are demanded. They are used globally in gas processing plants using molecular sieve systems in switching service.

- **No Rubbing Between Sealing Surfaces**

The tilt-and-turn action eliminates seal abrasion, which is the major cause of seat wear in conventional ball, gate and plug valves.

- **Injectable Packing**

For in-service maintenance, stem packing material is injected through the packing fitting, giving complete control of fugitive emissions. (Available on all enclosed bonnet models.)

- **Single-seat Design**

The single, stationary seat in the ORBIT valve seals in both directions and avoids the problems of trapped pressure between seals.

- **Long Life**

ORBIT valves replace troublesome ball valves, gate valves, globe valves and plug valves. The ORBIT design has performance advantages that reduce plant outage and reduce the cost of ownership.

- **Optimum Flow**

Full port or reduced port openings give high C_v figures. System pumping efficiency is enhanced and erosion problems are reduced.

- **Top-entry Design**

In-line inspection and repair, after system depressurizing, simplifies maintenance.

- **Dual Stem Guides**

Hardened stem slots and tough guide pins control the lift-and-turn action of the stem.

- **Self-cleaning**

Tilting the core away from the seat before rotation causes immediate flow around 360 degrees of the core face. Product flow flushes any foreign material away from the seat without localized, high-velocity erosive flow.

- **Low-torque Operation**

ORBIT valves turn easily because seal rubbing is eliminated.

- **Wear-resistant Hard Facing on Core**

The core face is a hard, polished material that will endure difficult service, without loss of sealing integrity.

- **Mechanical Cam Closure**

The cam angle at the lower end of the stem provides a mechanically energized seal.

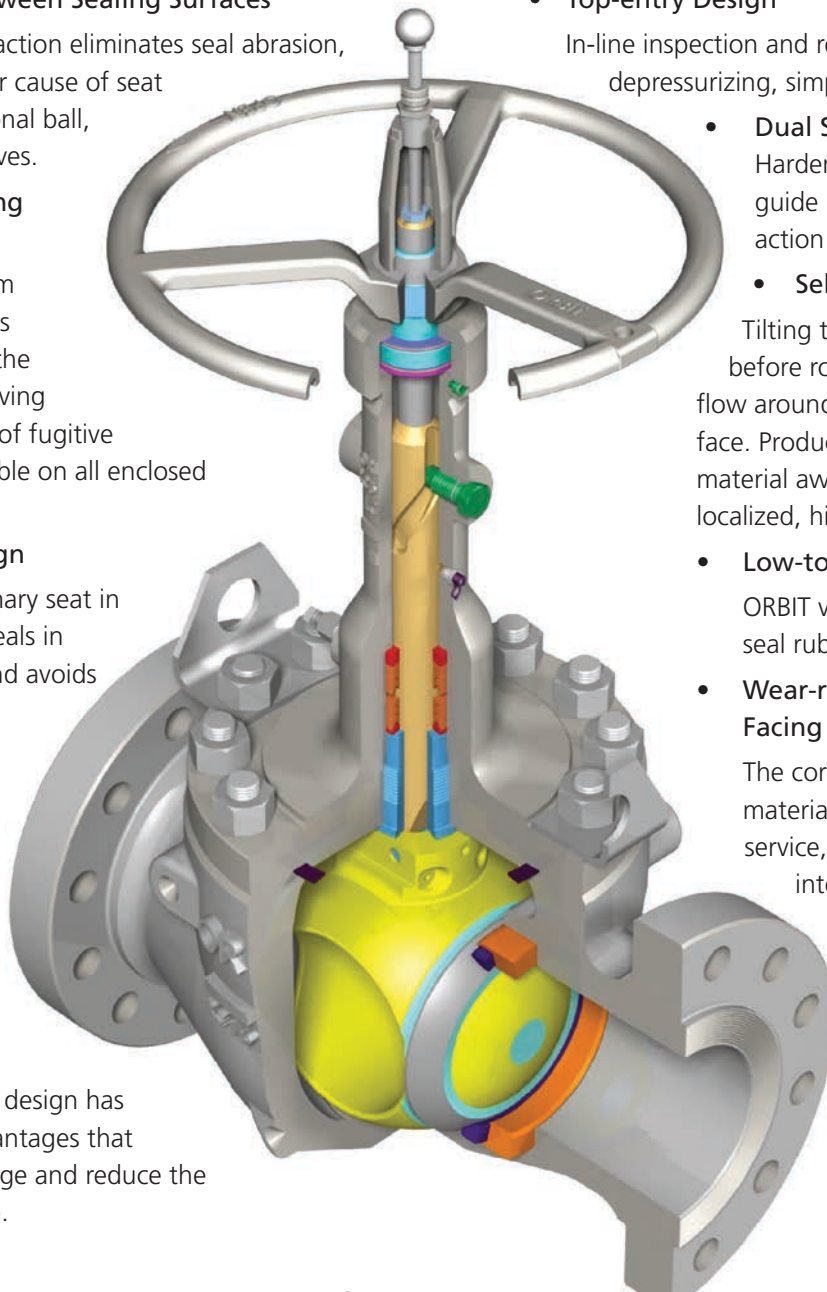

NOTE: Never remove any part from an ORBIT valve unless specifically instructed to do so in the literature, or without first consulting a Cameron representative. Incorrect procedure could result in personal injury and/or property damage.

QUALITY ASSURANCE

Cameron's Little Rock, Ark., US, manufacturing facility has quality programs that are ISO 9001 registered.

Specifications and Compliances

- API 6D
- ISO 9001:2008
- PED 97/23/EC
- ATEX Directive 94/9/EC
- GOST
- GOST-R Certificate and RTN Permit
- ISO 15848-1 (Fugitive Emission Type Testing)
- Shell GSI SPE 77/300 TAT Qualified and TAMAP Two-Star Rating
- ASME B16.34

Cameron's manufacturing philosophy and the standard 36-month warranty ensures that the design, materials and workmanship of all ORBIT products result in years of dependable operation.

Certifications for hydrostatic test results and material properties are available on request.



Gas testing and certification to the latest industry standards is performed by independent inspectors.



The Little Rock facility has undergone a new layout reorganization and CAPEX investment in state-of-the-art equipment.



Every ORBIT valve built is individually pressure tested to meet or exceed industry standards.

OPERATING PRINCIPLE

Every ORBIT valve incorporates a proven tilt-and-turn operation that eliminates seal rubbing, which is the primary cause of valve failure.

When an ORBIT valve is closed, the core is mechanically wedged tightly against the seat, ensuring positive shutoff.

When an ORBIT valve begins to open, the core tilts away from the seat and line flow passes uniformly around the core face. This eliminates the localized high-velocity flow that typically creates uneven seat wear in ordinary ball, gate and plug valves. The core then rotates to the fully open position.

The absence of seal rubbing during both opening and closing means easy, low-torque valve operation and long-term reliable performance.

When valve leakage cannot be tolerated, Cameron's ORBIT operating principle can be relied upon to deliver a positive shutoff.

To Close an ORBIT Valve

To close an ORBIT valve, as the handwheel is turned, the stem begins to lower.

Precision spiral grooves in the stem act against fixed guide pins, causing the stem and core to rotate.

Continued turning of the handwheel rotates the core and stem a full 90 degrees without the core touching the seat.

Final turns of the handwheel mechanically wedge the stem down, pressing the core firmly against the seat.

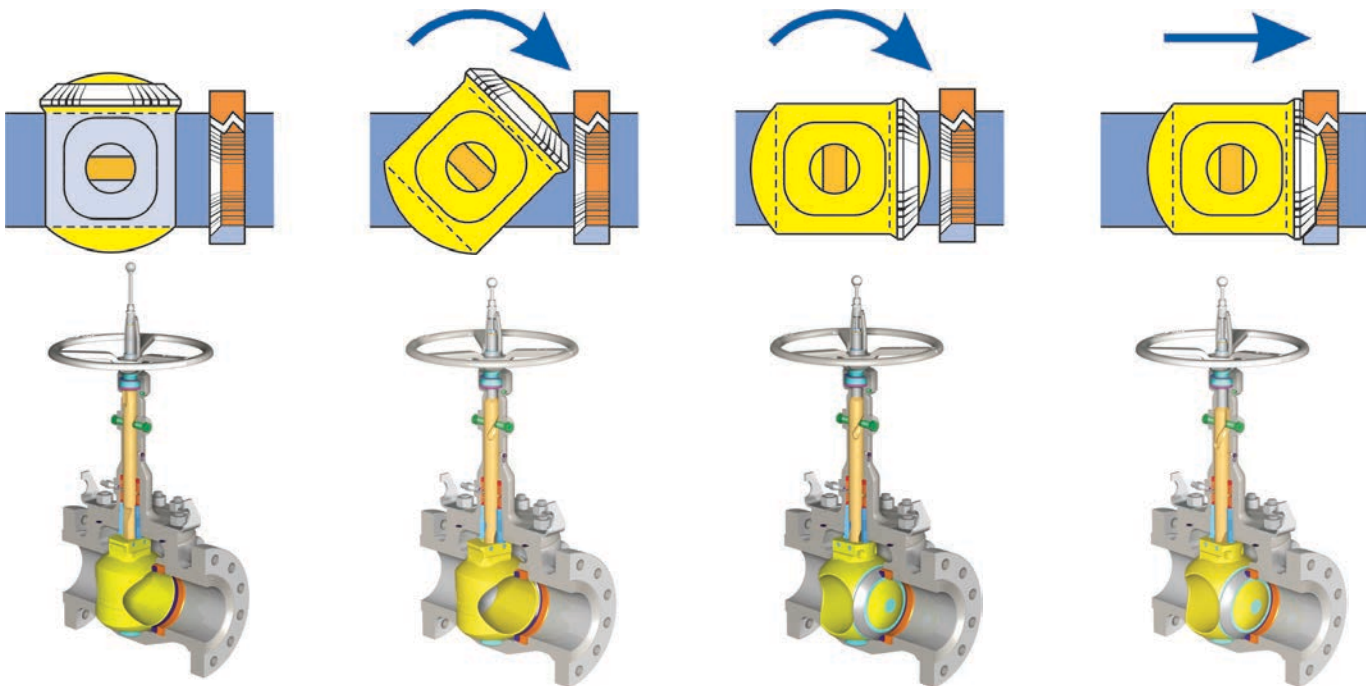

MARKET OPERATIONS

ORBIT valves are ideally suited for:

- Mol sieve dehydration switches valves
- Flowlines
- Meter isolation
- Dryer switching
- Block and bypass
- Product segregation
- Emergency shutdown
- Suction and discharge isolation
- Heat transfer fluids/hot oil
- Hydrogen service
- Many additional applications



ORBIT valves are ideal where frequent cycling and a positive shutoff are required, conditions that are prevalent in molecular sieve applications in gas processing plants.



The ORBIT valve's top-entry design provides convenient access for in-line inspection and repairs, when required. For environmental protection, injectable packing can be replenished while valves are under full line pressure on enclosed bonnet models.



An ORBIT model is displayed at the customer show room in Little Rock, Ark., US.

PRODUCT RANGE AND OPTIONS

ORBIT valves are manufactured in a variety of materials, sizes and trims to meet specific requirements.

Materials

Carbon steel, stainless steel, duplex SS, high-nickel alloys and other special materials are used as service conditions require. External protective coatings are available for added durability in corrosive environments.

Seats

Soft or metal-seated options are selected for the intended service. Because the seals in the valves do not rub, and because they are mechanically compressed shut, they survive in high-temperature and abrasive situations.

Operation

Hand or power operation can be selected. Cameron's ORBIT brand offers double-acting, spring-close and spring-open pneumatic actuators. User-selected electric and hydraulic actuators are available. Instrumentation choices also are offered.

Customizing

Handwheel extensions, safety interlocks, position indicator limit switches, thermal jackets, custom painting and special inspection can be provided.

Maintenance and Repairs

Cameron's CAMSERV™ services include inspection, maintenance and repairs for all ORBIT valve products.



Cameron's ORBIT brand offers complete packages that can include valves, actuators and instrumentation.

HOW TO ORDER

Sizes Available

ASME Class (PN)		150 (20)	300 (50)	600 (100)	900 (150)	1500 (250)	2500 (420)
Reduced Port, Flanged	in. (mm)	2 through 30 (50 through 750)	2 through 30 (50 through 750)	2 through 26 (50 through 650)	3 through 24 (80 through 600)	3 through 20 (80 through 500)	3 through 16 (80 through 400)
Full Port, Flanged		1 through 24 (25 through 600)	1 through 24 (25 through 600)	1 through 24 (25 through 600)	1 through 20 (25 through 500)	1 through 16 (25 through 400)	2 through 12 (50 through 300)
Reduced Port, Butt Weld		3 through 20 (80 through 500)	3 through 20 (80 through 500)	3 through 20 (80 through 500)	3 through 20 (80 through 500)	3 through 18 (80 through 450)	3 through 12 (80 through 300)
Full Port, Butt Weld		2 through 16 (50 through 400)	2 through 16 (50 through 400)	2 through 16 (50 through 400)	2 through 16 (50 through 400)	2 through 16 (50 through 400)	2 through 10 (50 through 250)
Full Port, Butt Weld x Flanged		-	2 through 16 (50 through 400)	-	-	-	-
Full Port, Socket Weld		-	-	1 through 2 (25 through 50)	1 through 2 (25 through 50)	1 through 2 (25 through 50)	1 (25)
Full Port, Threaded		-	-	1 through 3 (25 through 80)	1 through 3 (25 through 80)	1 through 2 (25 through 50)	1 (25)

Ordering Information

How to develop figure numbers:

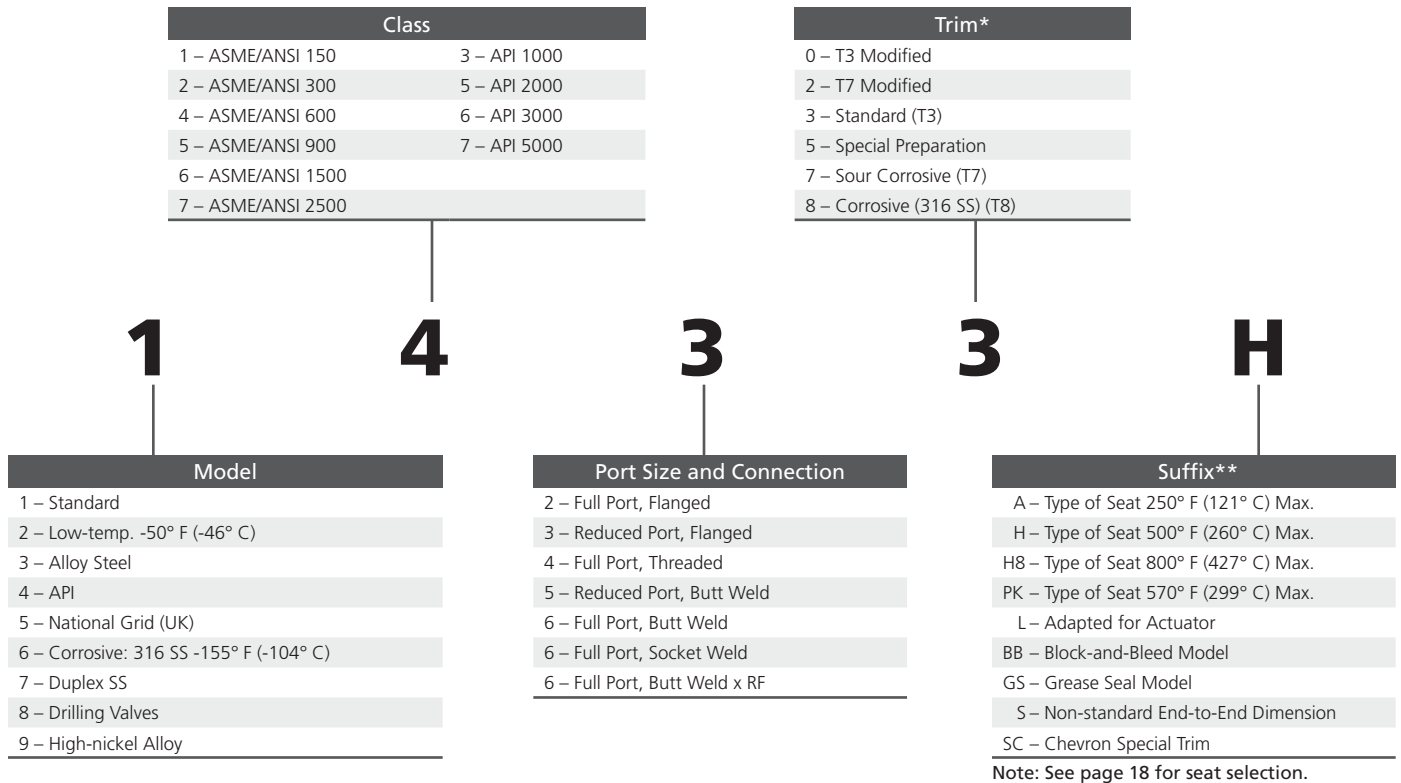

Note: See page 18 for seat selection.

Example

1433H = Standard, ASME/ANSI Class 600, Reduced Port, Flanged, Standard (T3)

* For a more complete explanation of trims and figure numbers, consult your Cameron representative.

** Valve figure number may use more than one suffix. Example: 1433H8L.

Cameron reserves the right to substitute materials listed on the following pages with alternate materials for the designated service.

ONE-PIECE STEM, ENCLOSED BONNET VALVES

Details and Materials

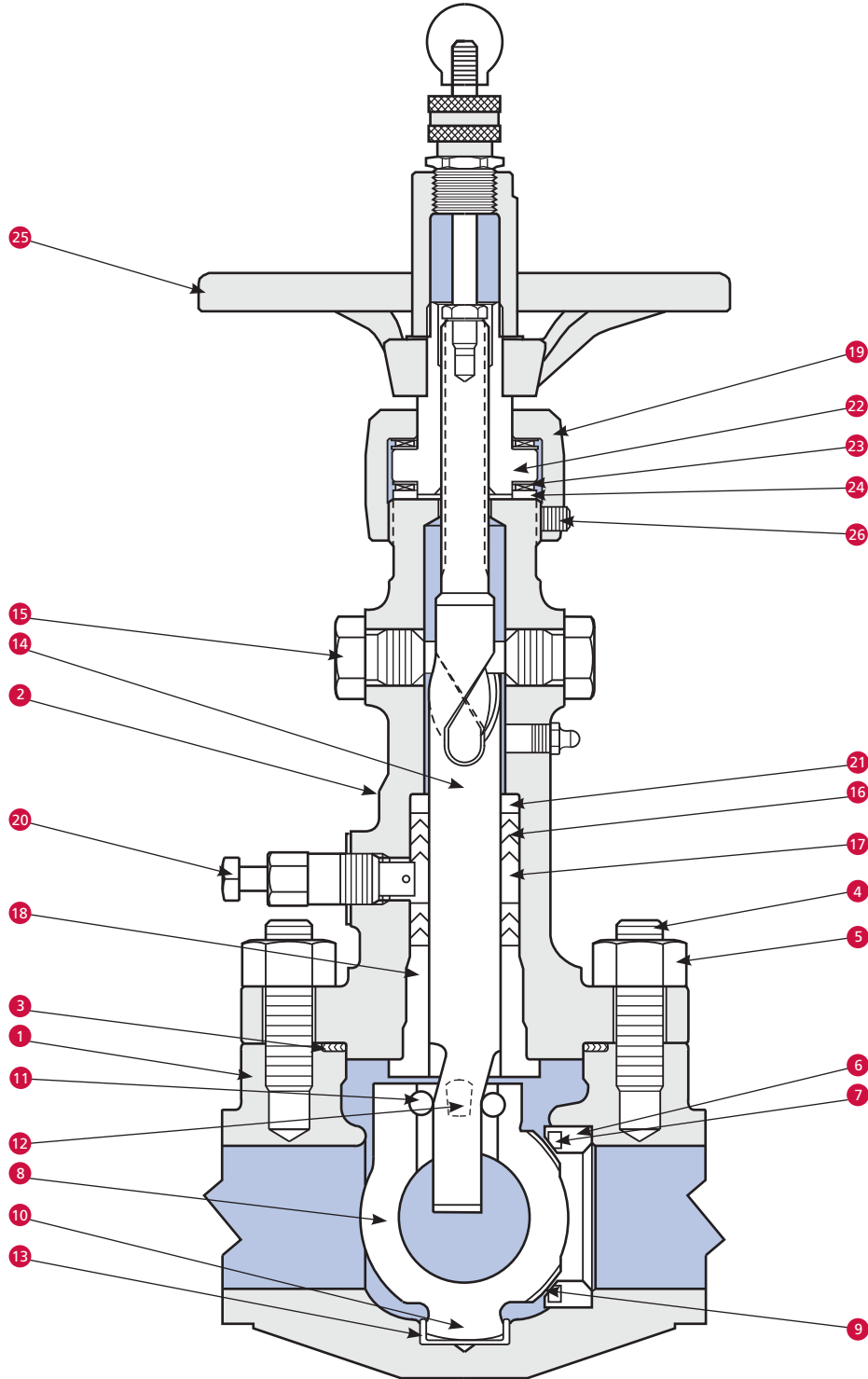

Materials List

Parts Description	Standard T3	Standard T7	Low-temp. T3	Low-temp. T7
	-20° F to 500° F (-29° C to 260° C)	-20° F to 500° F (-29° C to 260° C)	-50° F to 500° F (-46° C to 260° C)	-50° F to 500° F (-46° C to 260° C)
1 Body	ASTM A216 Gr. WCC	ASTM A216 Gr. WCC	ASTM A352 Gr. LCC	ASTM A352 Gr. LCC
2 Bonnet	ASTM A216 Gr. WCC	ASTM A216 Gr. WCC	ASTM A352 Gr. LCC	ASTM A352 Gr. LCC
3 Gasket	Stainless Steel and Graphite	Stainless Steel and Graphite	Stainless Steel and Graphite	Stainless Steel and Graphite
4 Stud	ASTM A193 Gr. B7	ASTM A193 Gr. B7M	ASTM A320 Gr. L7	ASTM A320 Gr. L7M
5 Nut	ASTM A194 Gr. 2H	ASTM A194 Gr. 2HM	ASTM A194 Gr. 4 or 7	ASTM A194 Gr. 7M
6 Seat Body	Stainless Steel	Stainless Steel	Stainless Steel	Stainless Steel
7 Seat Insert	Teflon®	Teflon	Teflon	Teflon
8 Core	ASTM A216 Gr. WCC	ASTM A216 Gr. WCC	ASTM A216 Gr. WCC	ASTM A216 Gr. WCC
9 Core Face	Nickel	Nickel-based CRA	Nickel	Nickel-based CRA
10 Trunnion Overlay	–	Nickel-based CRA	–	Nickel-based CRA
11 Core Pin	Stainless Steel	Nickel-based CRA	Stainless Steel	Nickel-based CRA
12 Support Pin	Stainless Steel	Stainless Steel	Stainless Steel	Stainless Steel
13 Trunnion Bushing	Stainless Steel	Stainless Steel	Stainless Steel	Stainless Steel
14 Stem	Alloy Steel	Stainless Steel	Alloy Steel	Stainless Steel
15 Stem Guide	Alloy Steel	Stainless Steel	Alloy Steel	Stainless Steel
16 Packing Rings	Teflon	Teflon	Teflon	Teflon
17 Injectable Packing	ORBIT GP6	ORBIT GP6	ORBIT GP6	ORBIT GP6
18 Bonnet Bushing	Stainless Steel	Stainless Steel	Stainless Steel	Stainless Steel
19 Bonnet Nut	Carbon Steel	Carbon Steel	Carbon Steel	Carbon Steel
20 Packing Fitting	Stainless Steel	Stainless Steel	Stainless Steel	Stainless Steel
21 Packing Chamber Bushing	Carbon Steel	Carbon Steel	Carbon Steel	Carbon Steel
22 Drive Nut	Ductile Ni-resist	Alloy Steel	Alloy Steel	Alloy Steel
23 Bearing	Alloy Steel	Alloy Steel	Alloy Steel	Alloy Steel
24 Bearing Race	Alloy Steel	Alloy Steel	Alloy Steel	Alloy Steel
25 Handwheel	Ductile Iron	Ductile Iron	Ductile Iron	Ductile Iron
26 Set Screw	Alloy Steel	Alloy Steel	Alloy Steel	Alloy Steel

Actual materials of construction will depend on the valve size, pressure class, end configuration and service conditions. Consult Cameron for a detailed materials list.

This is a partial list of material options. Many alternatives can be provided to match the actual service requirements.

Materials List

Parts Description	Standard T3	Standard T7	Low-temp. T3	Low-temp. T7
	-20° F to 500° F (-29° C to 260° C)	-20° F to 500° F (-29° C to 260° C)	-50° F to 500° F (-46° C to 260° C)	-50° F to 500° F (-46° C to 260° C)
1 Body	ASTM A216 Gr. WCC	ASTM A216 Gr. WCC	ASTM A352 Gr. LCC	ASTM A352 Gr. LCC
2 Bonnet	ASTM A216 Gr. WCC	ASTM A216 Gr. WCC	ASTM A352 Gr. LCC	ASTM A352 Gr. LCC
3 Gasket	Stainless Steel and Graphite	Stainless Steel and Graphite	Stainless Steel and Graphite	Stainless Steel and Graphite
4 Stud	ASTM A193 Gr. B7	ASTM A193 Gr. B7M	ASTM A320 Gr. L7	ASTM A320 Gr. L7M
5 Nut	ASTM A194 Gr. 2H	ASTM A194 Gr. 2HM	ASTM A194 Gr. 7	ASTM A194 Gr. 7M
6 Seat Body	Stainless Steel	Stainless Steel	Stainless Steel	Stainless Steel
7 Seat Insert	Teflon	Teflon	Teflon	Teflon
8 Core	ASTM A216 Gr. WCC	ASTM A216 Gr. WCC	ASTM A216 Gr. WCC	ASTM A216 Gr. WCC
9 Core Face	Nickel	Nickel-based CRA	Nickel	Nickel-based CRA
10 Trunnion Overlay	–	Nickel-based CRA	–	Nickel-based CRA
11 Core Pin	Stainless Steel	Stainless Steel	Stainless Steel	Stainless Steel
12 Support Pin	Stainless Steel	Stainless Steel	Stainless Steel	Stainless Steel
13 Trunnion Bushing	Stainless Steel	Stainless Steel	Stainless Steel	Stainless Steel
14 Stem	Stainless Steel	Stainless Steel	Stainless Steel	Stainless Steel
15 Stem Cam	Alloy Steel	Stainless Steel	Alloy Steel	Stainless Steel
16 Stem Pin	Alloy Steel	Stainless Steel	Alloy Steel	Stainless Steel
17 Stem Guide	Alloy Steel	Stainless Steel	Alloy Steel	Stainless Steel
18 Packing Rings	Teflon	Teflon	Teflon	Teflon
19 Injectable Packing	ORBIT GP6	ORBIT GP6	ORBIT GP6	ORBIT GP6
20 Bonnet Sleeve	Stainless Steel	Stainless Steel	Stainless Steel	Stainless Steel
21 Packing Fitting	Stainless Steel	Stainless Steel	Stainless Steel	Stainless Steel
22 Packing Chamber Bushing	Carbon Steel	Carbon Steel	Carbon Steel	Carbon Steel
23 Drive Nut	Ductile Ni-resist	Alloy Steel	Alloy Steel	Alloy Steel
24 Drive Nut Retainer	ASTM A216 Gr. WCC	ASTM A216 Gr. WCC	ASTM A216 Gr. WCC	ASTM A216 Gr. WCC
25 Bearing	Alloy Steel	Alloy Steel	Alloy Steel	Alloy Steel
26 Bearing Race	Alloy Steel	Alloy Steel	Alloy Steel	Alloy Steel
27 Handwheel	Ductile Iron	Ductile Iron	Ductile Iron	Ductile Iron
28 Position Indicator Rod	Stainless Steel	Stainless Steel	Stainless Steel	Stainless Steel
29 Packing Gland	Aluminum Bronze	Carbon Steel	Carbon Steel	Carbon Steel
30 Packing Gland Retainer	Carbon Steel	Carbon Steel	Carbon Steel	Carbon Steel

Actual materials of construction will depend on the valve size, pressure class, end configuration and service conditions.

Consult Cameron for a detailed materials list.

This is a partial list of material options. Many alternatives can be provided to match the actual service requirements.

ONE-PIECE STEM, OS&Y BONNET VALVES

Details and Materials

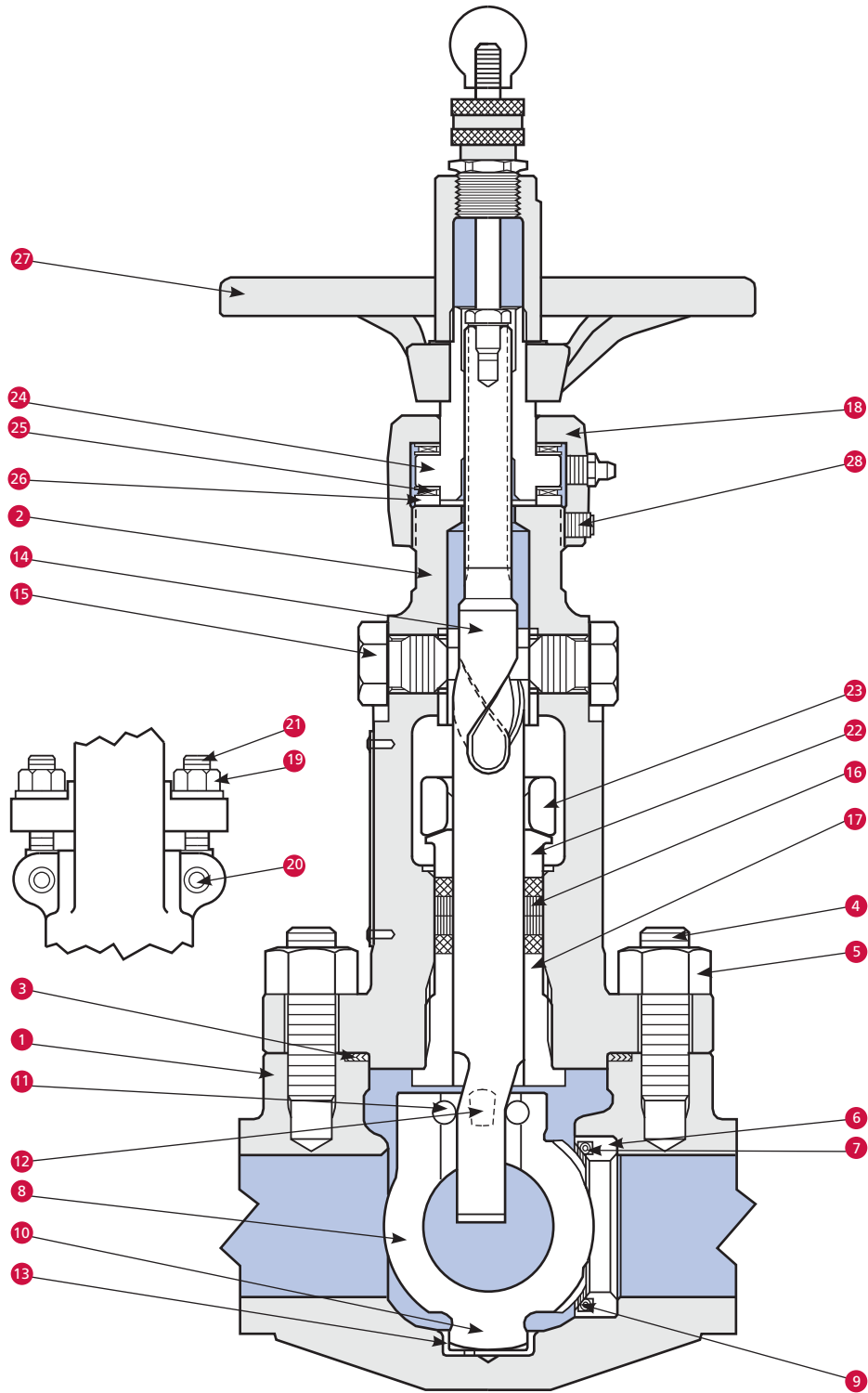

Materials List

Parts Description		Standard T3 -20° F to 800° F (-29° C to 427° C)	Standard T7 -20° F to 650° F (-29° C to 343° C)
1	Body	ASTM A216 Gr. WCC	ASTM A216 Gr. WCC
2	Bonnet	ASTM A216 Gr. WCC	ASTM A216 Gr. WCC
3	Gasket	Stainless Steel and Graphite	Stainless Steel and Graphite
4	Stud	ASTM A193 Gr. B7	ASTM A193 Gr. B7M
5	Nut	ASTM A194 Gr. 2H	ASTM A194 Gr. 2HM
6	Seat Body	Stainless Steel	Stainless Steel
7	Seat Insert	Stainless Steel	Stainless Steel
8	Core	ASTM A216 Gr. WCC	ASTM A216 Gr. WCC
9	Core Face	Nickel	Cobalt Alloy
10	Trunnion Overlay	–	Nickel-based CRA
11	Core Pin	Stainless Steel	Stainless Steel
12	Support Pin	Stainless Steel	Stainless Steel
13	Trunnion Bushing	Stainless Steel	Stainless Steel
14	Stem	Alloy Steel	Stainless Steel
15	Stem Guide	Alloy Steel	Stainless Steel
16	Packing Rings	Graphite and Carbon	Graphite and Carbon
17	Bonnet Bushing	Stainless Steel	Stainless Steel
18	Bonnet Nut	Carbon Steel	Carbon Steel
19	Packing Eyebolt Nut	ASTM A194 Gr. 2H	ASTM A193 Gr. 2HM
20	Packing Eyebolt Pin	Stainless Steel	Stainless Steel
21	Packing Eyebolt	Stainless Steel	Stainless Steel
22	Packing Gland	Ductile Iron	Ductile Iron
23	Packing Gland Retainer	ASTM A216 Gr. WCC	ASTM A216 Gr. WCC
24	Drive Nut	Ductile Ni-resist	Alloy Steel
25	Bearing	Alloy Steel	Alloy Steel
26	Bearing Race	Alloy Steel	Alloy Steel
27	Handwheel	Ductile Iron	Ductile Iron
28	Set Screw	Alloy Steel	Alloy Steel

Actual materials of construction will depend on the valve size, pressure class, end configuration and service conditions.

Consult Cameron for a detailed materials list.

This is a partial list of material options. Many alternatives can be provided to match the actual service requirements.

TWO-PIECE STEM, OS&Y BONNET VALVES

Details and Materials

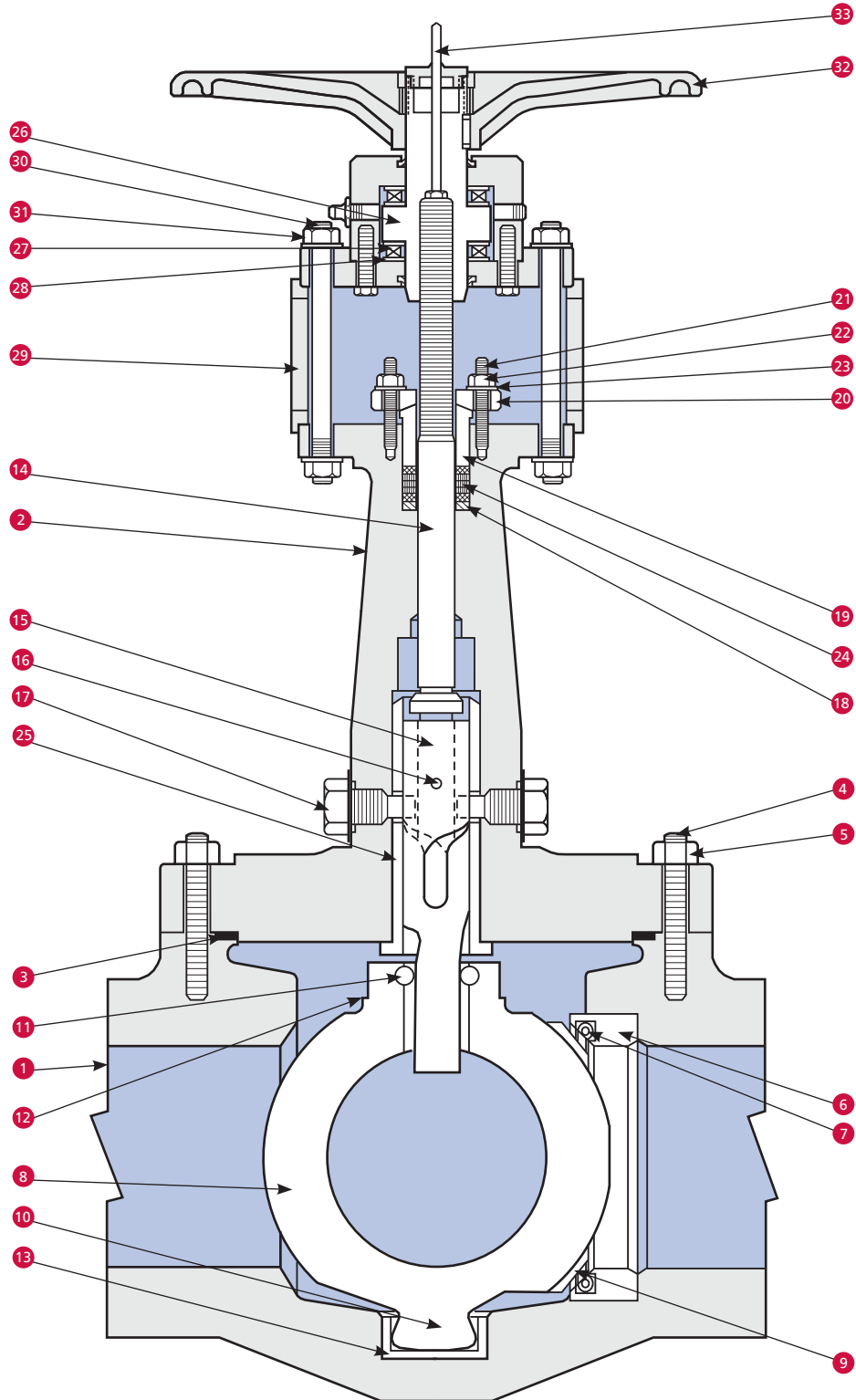

Materials List

Parts Description		Standard T3 -20° F to 800° F (-29° C to 427° C)	Standard T7 -20° F to 650° F (-29° C to 343° C)
1	Body	ASTM A216 Gr. WCC	ASTM A216 Gr. WCC
2	Bonnet	ASTM A216 Gr. WCC	ASTM A216 Gr. WCC
3	Gasket	Stainless Steel and Graphite	Stainless Steel and Graphite
4	Stud	ASTM A193 Gr. B7	ASTM A193 Gr. B7M
5	Nut	ASTM A194 Gr. 2H	ASTM A194 Gr. 2HM
6	Seat Body	Stainless Steel	Stainless Steel
7	Seat Insert	Stainless Steel	Stainless Steel
8	Core	ASTM A216 Gr. WCC	ASTM A216 Gr. WCC
9	Core Face	Nickel	Cobalt Alloy
10	Trunnion Overlay	–	Nickel-based CRA
11	Core Pin	Stainless Steel	Stainless Steel
12	Support Pin	Stainless Steel	Stainless Steel
13	Trunnion Bushing	Stainless Steel	Stainless Steel
14	Stem	Stainless Steel	Stainless Steel
15	Stem Cam	Alloy Steel	Stainless Steel
16	Stem Pin	Alloy Steel	Stainless Steel
17	Stem Guide	Alloy Steel	Stainless Steel
18	Packing Chamber Bushing	Carbon Steel	Carbon Steel
19	Packing Gland	Ductile Iron	Ductile Iron
20	Packing Gland Retainer	ASTM A216 Gr. WCC	ASTM A216 Gr. WCC
21	Stud	ASTM A193 Gr. B7	ASTM A193 Gr. B7M
22	Nut	ASTM A194 Gr. 2H	ASTM A194 Gr. 2HM
23	Washer	Carbon Steel	Carbon Steel
24	Packing Rings	Graphite and Carbon	Graphite and Carbon
25	Bonnet Sleeve	Stainless Steel	Stainless Steel
26	Drive Nut	Ductile Ni-resist	Alloy Steel
27	Bearing	Alloy Steel	Alloy Steel
28	Bearing Race	Alloy Steel	Alloy Steel
29	Packing Access Sleeve	Carbon Steel	Carbon Steel
30	Stud	ASTM A193 Gr. B7	ASTM A193 Gr. B7
31	Nut	ASTM A194 Gr. 2H	ASTM A194 Gr. 2H
32	Handwheel	Ductile Iron	Ductile Iron
33	Position Indicator Rod	Stainless Steel	Stainless Steel

Actual materials of construction will depend on the valve size, pressure class, end configuration and service conditions. Consult Cameron for a detailed materials list. This is a partial list of material options. Many alternatives can be provided to match the actual service requirements.

END FLANGE BOLTING DIMENSIONS

ASME/ ANSI	Class 150				Class 300				Class 600				
	Valve Size in.	Number of Fasteners per Valve	Fastener Diameter in.	Length of Studs in.	*Length of Capscrews in.	Number of Fasteners per Valve	Fastener Diameter in.	Length of Studs in.	*Length of Capscrews in.	Number of Fasteners per Valve	Fastener Diameter in.	Length of Stud RF in. RTJ in.	*Length of Capscrew in.
1	8	1/2	3	–	8	5/8	3-1/4	–	8	5/8	3-1/2	3-1/2	–
1-1/2	8	1/2	3-1/4	–	8	3/4	3-1/2	–	8	3/4	4-1/4	4-1/4	–
2 x 1-1/2 x 2	8	5/8	3-1/4	–	16	5/8	3-1/2	–	16	5/8	4-1/4	4-1/4	–
2	8	5/8	3-1/4	–	16	5/8	3-1/2	–	16	5/8	4-1/4	4-1/4	–
2 BB/GS	8	5/8	3-1/4	–	–	–	–	–	–	–	–	–	–
3 x 2 x 3	8	5/8	3-1/2	–	16	3/4	4-1/4	–	16	3/4	5	5	–
3*	8	5/8	2-1/2	1-1/2	16	3/4	4-1/4	–	16	3/4	5	5	–
4 x 3 x 4*	16	5/8	2-3/4	1-3/4	16	3/4	4-1/2	–	16	7/8	5-3/4	5-3/4	–
4*	16	5/8	2-3/4	1-3/4	12	3/4	4-1/2	–	16	7/8	5-3/4	5-3/4	–
	–	–	–	–	4	3/4	–	2-1/4	–	–	–	–	–
6 x 4 x 6	16	3/4	4	–	24	3/4	4-3/4	–	24	1	6-3/4	6-3/4	–
6*	16	3/4	3	2	16	3/4	4-3/4	–	24	1	6-3/4	6-3/4	–
	–	–	–	–	8	3/4	–	2-1/2	–	–	–	–	–
8 x 6 x 8	16	3/4	4-1/4	–	24	7/8	5-1/2	–	24	1-1/8	7-1/2	7-3/4	–
8*	12	3/4	4-1/4	1-1/2	16	7/8	5-1/2	–	24	1-1/8	7-1/2	7-3/4	–
	4	3/4	–	2	8	7/8	–	3	–	–	–	–	–
10 x 8 x 10*	20	7/8	4-1/2	–	28	1	6-1/4	–	32	1-1/4	8-1/2	8-1/2	–
	4	7/8	4-1/2	2-1/4	4	1	–	3-3/4	–	–	–	–	–
10	24	7/8	4-1/2	–	32	1	6-1/4	–	32	1-1/4	8-1/2	8-1/2	–
12 x 10 x 12	24	7/8	4-3/4	–	32	1-1/8	6-3/4	–	40	1-1/4	8-3/4	8-3/4	–
12	24	7/8	4-3/4	–	32	1-1/8	6-3/4	–	40	1-1/4	8-3/4	8-3/4	–
14 x 12 x 14	24	1	5-1/4	–	40	1-1/8	7	–	40	1-3/8	9-1/4	9-1/4	–
14	–	–	–	–	40	1-1/8	7	–	40	1-3/8	9-1/4	9-1/4	–
16 x 12 x 16	–	–	–	–	–	–	–	–	40	1-1/2	10	10	–
16 x 14 x 16	32	1	5-1/4	–	40	1-1/4	7-1/2	–	–	–	–	–	–
16	32	1	5-1/4	–	40	1-1/4	7-1/2	–	40	1-1/2	10	10	–
18 x 16 x 18	32	1-1/8	5-3/4	–	48	1-1/4	7-3/4	–	40	1-5/8	10-3/4	11	–
20 x 16 x 20	40	1-1/8	6-1/4	–	48	1-1/4	8	–	48	1-5/8	11-1/4	11-1/2	–
18	32	1-1/8	6-1/4	–	–	–	–	–	–	–	–	–	–
20*	–	–	–	–	48	1-1/4	7-3/4	–	36	1-5/8	11-1/4	11-1/2	–
	–	–	–	–	–	–	–	–	12	1-5/8	–	–	5-3/4
24 x 20 x 24	–	–	–	–	48	1-1/2	9	–	48	1-7/8	13	13-1/4	–
24	–	–	–	–	48	1-1/2	9	–	48	1-7/8	13	13-1/4	–

* Space limitations prevent the use of through-bolts in some of the holes in the end flanges on these valves. These holes are drilled and tapped so that a shorter stud bolt or capscrew can be used.

ASME/ ANSI	Class 900				Class 1500				Class 2500			
	Valve Size in.	Number of Fasteners per Valve	Fastener Diameter in.	Length of Studs RF in. RTJ in.	Number of Fasteners per Valve	Fastener Diameter in.	Length of Studs RF in. RTJ in.	Number of Fasteners per Valve	Fastener Diameter in.	Length of Studs RF in. RTJ in.		
1	8	3/4	5	5	8	7/8	5	5	-	-	-	-
1-1/2	8	1	5-1/2	5-1/2	8	1	5-1/2	5-1/2	-	-	-	-
2	16	7/8	5-3/4	5-3/4	16	7/8	5-3/4	5-3/4	16	1	7	7
3 x 2 x 3	16	7/8	5-3/4	5-3/4	16	1-1/8	7	7	16	1-1/4	9	9-1/4
3	16	7/8	5-3/4	5-3/4	16	1-1/8	7	7	16	1-1/4	9	9-1/4
4 x 3 x 4	16	1-1/8	6-3/4	6-3/4	16	1-1/4	7-3/4	7-3/4	16	1-1/2	10-1/4	10-3/4
4	16	1-1/8	6-3/4	6-3/4	16	1-1/4	7-3/4	7-3/4	16	1-1/2	10-1/4	10-3/4
6 x 4 x 6	24	1-1/8	7-1/2	7-1/2	24	1-3/8	10-1/4	10-1/2	16	2	13-3/4	14-1/2
6	24	1-1/8	7-1/2	7-3/4	24	1-3/8	10-1/4	10-1/2	16	2	13-3/4	14-1/2
8 x 6 x 8	24	1-3/8	8-3/4	8-3/4	24	1-5/8	11-1/2	12-3/4	24	2	15-1/4	16
8	24	1-3/8	8-3/4	8-3/4	24	1-5/8	11-1/2	12-3/4	24	2	15-1/4	16
10 x 8 x 10	32	1-3/8	9-1/4	9-1/4	24	1-7/8	13-1/4	13-1/2	24	2-1/2	19-1/2	20-1/2
10	32	1-3/8	9-1/4	9-1/4	24	1-7/8	13-1/4	13-1/2	-	-	-	-
12 x 10 x 12	40	1-3/8	10	10	32	2	14-3/4	15-1/4	-	-	-	-
12	40	1-3/8	10	10	32	2	14-3/4	15-1/4	-	-	-	-
14 x 12 x 14	40	1-1/2	10-3/4	11	32	2 1/4	16	16-3/4	-	-	-	-
16 x 12 x 16	40	1-5/8	11-1/4	11-1/2	32	2-1/2	17-1/2	18-1/2	-	-	-	-
16	40	1-5/8	11-1/4	11-1/2	32	2-1/2	17-1/2	18-1/2	-	-	-	-
18 x 16 x 18	40	1-7/8	12-3/4	13-1/4	-	-	-	-	-	-	-	-
20 x 16 x 20	40	2	13-3/4	14-1/4	32	3	21-1/4	22-1/4	-	-	-	-
20	40	2	13-3/4	14-1/4	-	-	-	-	-	-	-	-

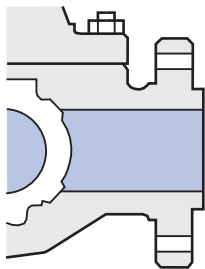

ASME/ANSI
Raised-face
Flanged

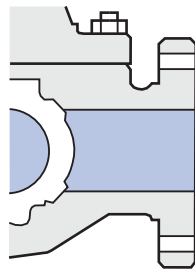

ASME/ANSI
Flat-face
Flanged

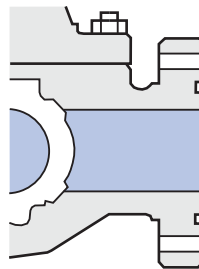

RTJ
(RG)
Flanged

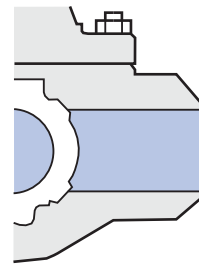

Butt
Weld

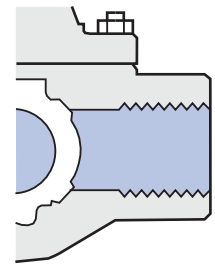

Socket Weld
or
Threaded

SEAT AND STEM PACKING SELECTION

Seat Selection

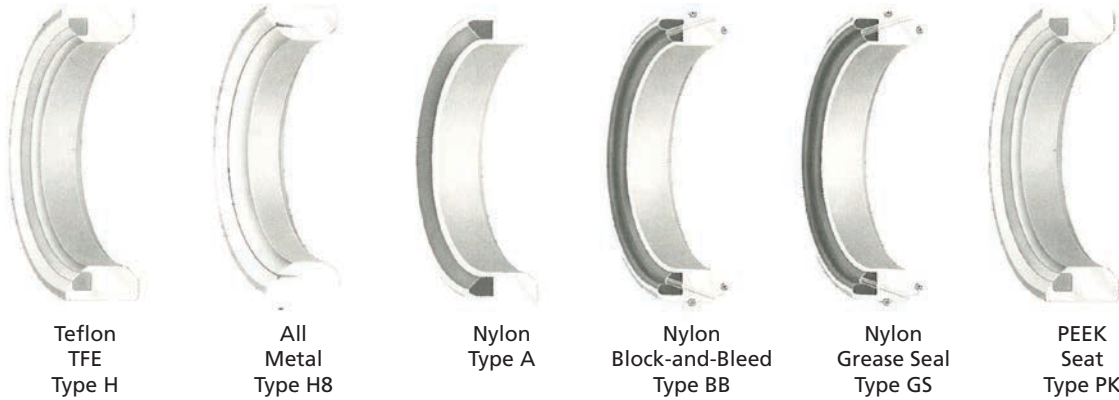

Temperature	Insert Material	Support Ring	Bore Sizes (in.)	Seat Options
-50° F to 250° F (-46° C to 121° C)	Nylon	Carbon Steel	2 to 16	Type A, BB and GS
-50° F to 250° F (-46° C to 121° C)	Nylon	Stainless Steel	2 to 16	Type A, BB and GS
-155° F to 500° F (-46° C to 260° C)	Teflon TFE	Stainless Steel	1 to 24	Type H
-155° F to 800° F (-104° C to 427° C)	–	Stainless Steel	1	Type H8
-155° F to 800° F (-104° C to 427° C)	Stainless Steel Tube	Stainless Steel	1-1/2 to 24	Type H8
-50° F to 570° F (-46° C to 300° C)	PEEK*	Stainless Steel	2 to 12	Type PK

Stem Packing Selection

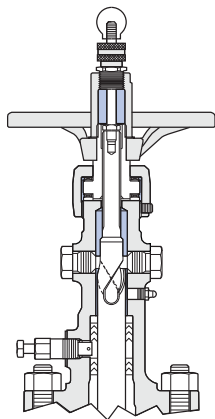

Standard Injectable Packing

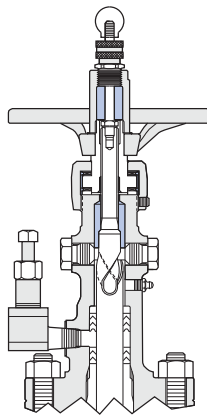

Low-temperature Injectable Packing

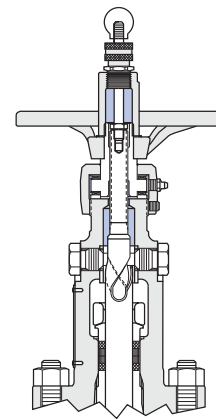

OS&Y Packing

Temperature/Service	Packing Material	ORBIT Designation
-50° F to 500° F (-46° C to 260° C)	Injectable Teflon Packing with Fire-safe Graphite Top Ring	GP6
-50° F to 800° F (-46° C to 427° C)	Graphite Rings with OS&Y Packing	GP20
	*-155° F (104° C) for 316 SS Valve	
-30° F to 550° F (-34° C to 288° C)	Injectable Teflon Packing with Fire-safe Graphite Top Ring	GP19
	Ammonia Service	
-20° F to 400° F (-29° C to 204° C)	Injectable Teflon Packing with Teflon Rings	GP27
	MTBE Service	
-30° F to 275° F (-34° C to 135° C)	Injectable Teflon Packing with Teflon Rings	GP7
	Oxygen Service	

Other packing materials available.

MARKINGS

Valves & Measurement		STANDARD TRIM	
ORBIT			
SIZE	3" 900 CL	END TO END	15"
FIG	1523H RF	1995 MOP AT	+500F
SN	110091620001	2250 MOP AT	-20F
PKG	GP6	STEM	CR13
SEAT	CR13 TEF	BODY STEEL	WCC
MFG	6D-0073	CORE TRIM	CR13
DATE	04/01 ISO 14313	CORE FACE	NI
IMPACT TEMP	-50F	TEMP	-20/+500F
 CAMERON		Little Rock, AR USA	

Nameplate Markings for Valve Trim

AS	Alloy Steel
15-6	Carpenter 450° Stainless Steel
660	A-638 (Grade 660)
HF-C	Hardfacing Hastelloy C° and C-276
C-276	Hastelloy C-276°
MP35N	Latrobe°
CO-U	Cobalt-Based Ultimet°
NICU	Monel°
NI	Nickel
COCR	Stellite°
17-4	17-4PH Stainless Steel
CR13	410 and 420 Stainless Steel (13% Chrome)
718	Inconel 718°
316	316 Stainless Steel
NYL	Nylon
PEEK	Polyetheretherketone
TEF	Teflon

Nameplate Markings for Stem Packing

GP-6	General Service
GP-7	Oxygen Service
GP-19	Ammonia Service
GP-27	MTBE Service
Graphite	OS&Y (Graphite Rings)
GP-22	Injectable Graphite

Body Markings – ASME/ANSI Valve

The serial number is stamped into the side of the valve body or the OD of the flange. If the valve has ring joint facings, the ring gasket number is stamped into the OD of the flange. Preferred pressure end and seat size code are stamped on the OD of flanged valves and on the hub end of butt weld and threaded valves. The end connection size and class are stamped or cast on the body.

ACTUATOR FIGURE NUMBERS

Diaphragm Actuator

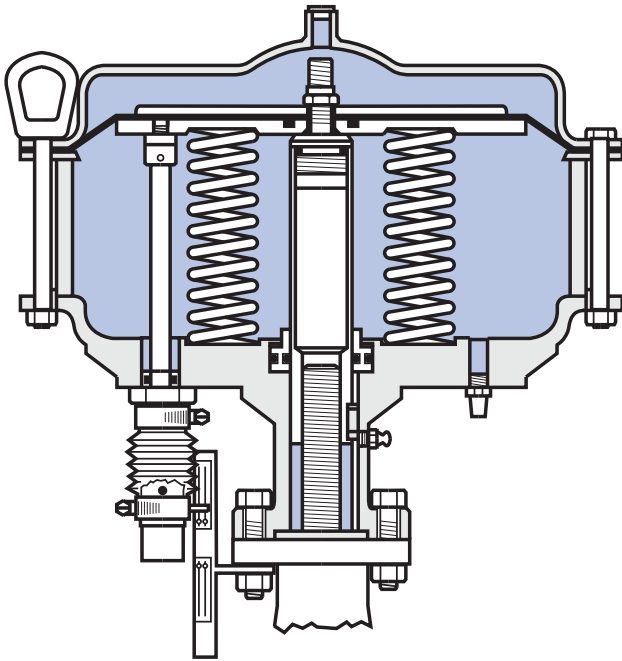

Double-acting Style

Example: 164100-280

First Figures (8, 16 or 42)
(Nominal Size of Diaphragm) x 10
8 = Approximately 80 sq in
16 = Approximately 160 sq in
42 = Approximately 420 sq in

Second Figure

(0)(4) etc. = Actuator/Valve Mounting Configuration

Third Figures

(100)(625)(1125) etc. = Valve Stem Thread Size

Fourth Figure

Available Accessories
275 = Manual Close Mechanism
280 = Two-way Manual Mechanism
301 = Snubber
376 = Snubber and Manual Close Mechanism
381 = Snubber Two-way Manual Mechanism

Spring-return Style

Example: 62585-275

First Figures

(100)(625)(1125) etc. = Valve Stem Thread Size

Second Figures (8, 16 or 42)

(Nominal Size of Diaphragm) x 10
8 = Approximately 80 sq in
16 = Approximately 160 sq in
42 = Approximately 420 sq in

Third Figure

Type of Spring-action and Mounting Configuration
0 = Spring Close, Threaded Adapter
3 = Spring Open, Threaded Adapter
4 = Spring Close, Flange Adapter
5 = Spring Open, Flange Adapter, etc.

Fourth Figure

Available Accessories
275 = Manual Close Mechanism for Spring Open
280 = Two-way Manual Mechanism for Spring Open
301 = Snubber
291 = Two-way Manual Mechanism for Spring Close
376 = Snubber and Manual Close Mechanism for Spring Open
381 = Snubber and Two-way Manual Mechanism for Spring Open

Piston Actuator

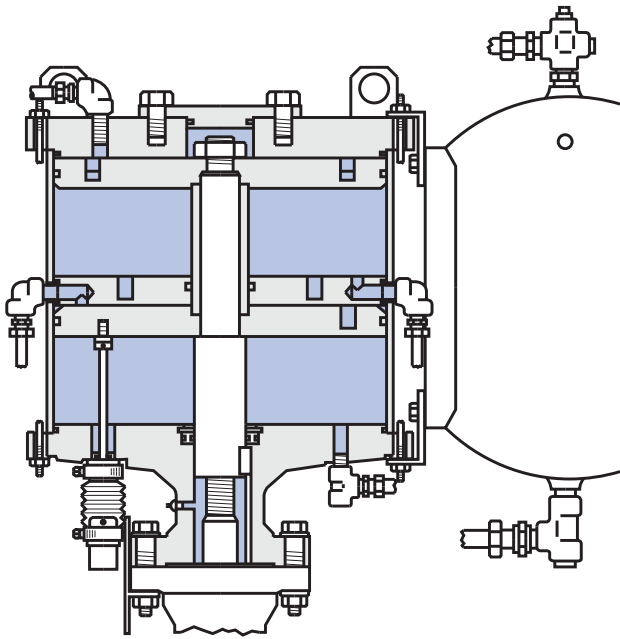

Example: LS-185-D-5-X-S

First Figure

L = Low-pressure Cylinder Actuator, 80 psi Maximum Pressure

Second Figure

G = Double-cylinder Damping or No Damping
S = Single-cylinder Damping

Third Figures

(12)(18)(20) etc. = Nominal Diameter of Actuator Piston (inches)

Fourth Figures

(3)(4)(5) etc. = Nominal Piston Stroke (inches)

Fifth Figure

(D)(T) etc. = Number of Cylinders (Double/Triple, etc.)

Sixth Figures

(1)(2)(3) etc. = Actuator/Valve Mounting Configuration
(Consult Cameron for specific details)

Seventh Figure

Accessory Features

C = Mechanical Override – Closed

H = Hydraulic Override – Open,
Mechanical Override – Closed

L = Positive Close Locking Device

M(N) = Mechanical Override – Open and Closed

O = Hydraulic Override – Open and Closed

X = No Accessory Features

Eighth Figure

S = Spring Return

ACTUATOR FIGURE NUMBERS (CONT.)

These are typical selections of actuators for soft-seated valves with standard T3 trim and pipeline pressure from the preferred end. The correct choice of actuator will depend on pressure direction, temperature, flow conditions, valve trim and valve end connections. Consult Cameron for the specific actuator/valve combination that is most suitable for the intended service.

ASME/ANSI Valve Size in.	Class 150			Class 300			Class 600		
	Double-acting Actuator	Spring-close Actuator	Spring-open Actuator	Double-acting Actuator	Spring-close Actuator	Spring-open Actuator	Double-acting Actuator	Spring-close Actuator	Spring-open Actuator
1	84625	62584	62588	84625	62584	62588	84625	62584	62588
1-1/2	84625	62584	62588	84625	62584	62588	84625	62584	62588
2	84625	62584	62588	84625	62584	62588	84625	62584	62588
3	84100	100164	100165	84100	100164	100165	164100	100164	100165
4	84100	100164	100165	84100	100164	100165	164100	100167	100165
6	164100	100167	–	164100	100167	*	164100	123424	*
8	164100	123424	*	164100	123424	*	424125-301	LS-185-D-25-X-S	*
10	424125-301	125424	*	424125-301	LS-185-D-25-X-S	*	LS-185-D-5	LS-205-D-5-X-S	*
12	LS-185-D-5	LS-185-D-5-X-S	*	LS-185-D-5	LS-205-D-5-X-S	*	LS-205-D-6	LS-205-D-6-X-S	*
14	–	–	–	LS-185-D-5	LS-205-D-X-S	*	LS-267-D-19	LS-267-D-19-X-S	*
16	LS-207-D-19	LS-267-D-X-S	*	LS-207-D-19	LS-267-D-19-X-S	*	LS-267-D-19	LS-267-D-19-X-S	*
18	LS-267-D-19	–	–	–	–	–	–	–	–
20	–	–	–	LG-2611-T-29	–	–	LG-2611-T-29	–	–
24	–	–	–	LG-4214-D-33	–	–	LG-4214-D-33	–	–

*Consult Cameron

ASME/ANSI Valve Size in.	Class 150			Class 300			Class 600		
	Double-acting Actuator	Spring-close Actuator	Spring-open Actuator	Double-acting Actuator	Spring-close Actuator	Spring-open Actuator	Double-acting Actuator	Spring-close Actuator	Spring-open Actuator
1	84625	62584	62588	84625	62584	62588	84625	62584	62588
1-1/2	164100	100164	*	164100	100164	*	–	–	–
1-3/4	–	–	–	–	–	–	164100	100164	*
2	164100	100164	100165	164100	100164	100165	–	–	–
3	164100	100164	100165	164100	100167	*	164101	120424	*
4	164100	100167	*	164100	121424	*	424125-301	125424	*
6	424125-301	LS-185-D-25-X-S	*	LS-185-D-5	LS-205-D-5-X-S	*	LS-185-D-5	LS-205-D-5-X-S	*
8	LS-185-D-15	LS-205-D-15-X-S	*	LS-208-D-31	*	*	LS-269-D-32	*	*
10	LS-205-D-16	LS-267-D-16-X-S	*	LS-269-D-32	*	*	–	–	–
12	LS-267-D-19	LS-267-D-19-X-S	*	LG-2611-T-29	*	*	–	–	–
16	LG-2611-T-29	–	–	LG-4214-D-33	–	–	–	–	–

*Consult Cameron

Electric Actuators

Cameron supplies electric actuated valve packages using many of the commercially available power actuators built by other companies. The electric actuator is selected, mounted, adjusted and tested by Cameron so that field performance of the entire valve assembly can be ensured.

Hydraulic Actuators

Commercially available hydraulic actuators built by other vendors are available upon request.

CAMSERV™ Services for Valves and Actuation

WE BUILD IT. WE BACK IT.



Global Network and Local Support

Cameron is well-positioned to deliver total aftermarket support, quickly and efficiently, with unmatched OEM expertise. Our highly skilled engineers and technicians are available around the clock, seven days a week to respond to customer queries, troubleshoot problems and offer reliable solutions.

Easily Accessible Parts and Spare Valves

- OEM spare valves, actuators and parts (including non-Cameron brands)
- Handling, storage, packaging and delivery
- Dedicated stocking program



Comprehensive Aftermarket Services Portfolio

- Parts and spare valves
- Repair
- Field services
- Preventative maintenance
- Equipment testing and diagnostics
- Remanufacturing
- Asset preservation
- Customer property management
- Training and recertification services
- Warranty



Customized Total Valve Care™ (TVC) Programs

Customized asset management plans that optimize uptime, availability and dedicated services.

- Engineering consultancy
- Site management
- Flange management
- Startup and commissioning
- Spare parts and asset management
- Operational support



Trademark Information

ORBIT® is a registered trademark of Cameron. CAMSERV is a trademark of Cameron.

This document contains references to registered trademarks or product designations that are not owned by Cameron.

Registered Trademark	Owner
Carpenter 450	Carpenter Technology Corp.
Hastelloy	Haynes International, Inc.
Inconel	INCO Nickel Sales, Inc.
Latrobe	Timkin Latrobe Steel
Monel	INCO Alloys International, Inc.
PEEK	Victrex PLC.
Stellite	Stoody Deloro Stellite, Inc.
Teflon	E.I. DuPont De Nemours & Company
Ultimet	Haynes International, Inc.



3250 Briarpark Drive, Suite 300
Houston, TX 77042
USA
Toll Free 1.800.323.9160

Learn more about ORBIT valves:

www.c-a-m.com/ORBIT

ORBIT@c-a-m.com



HSE Policy Statement

At Cameron, we are committed ethically, financially and personally to a working environment where no one gets hurt and nothing gets harmed.